

PRE-X EXPERIMENTAL RE-ENTRY LIFTING BODY: DESIGN OF FLIGHT TEST EXPERIMENTS FOR CRITICAL AEROTHERMAL PHENOMENA

Paolo Baiocco *

* CNES Direction des Lanceurs

Rond Point de l'Espace – 91023 Evry Cedex, France

Phone : +33 (0)1.60.87.72.14

Fax : +33 (0)1.60.87.72.66

E-mail : paolo.baiocco@cnes.fr

ABSTRACT

Atmospheric glided re-entry is one of the main key technologies for future space vehicle applications. In this frame Pre-X is the CNES proposal to perform in-flight experimentation mainly on reusable thermal protections, aero-thermo-dynamics and guidance to secure the second generation of re-entry X vehicles. This paper describes the system principles and main aerothermodynamic experiences currently foreseen on board the vehicle. A preliminary in-flight experimentation and measurement plan has been assessed defining the main objectives in terms of reusable Thermal Protection System (TPS) and Aero Thermo Dynamics (ATD) data on the most critical phenomena. This flight aims also to take the opportunity to fly some innovative measurements. A complete system loop has been performed including the operations, ground system assessment, and visibility analysis. The vehicle re-entry point is at 120 km and the mission objectives are fulfilled between Mach 25 and 5. Then the vehicle has to pass to subsonic speeds, the parachute opens and it is finally recovered in the sea. The VEGA and DNEPR launch vehicles are compatible of the Pre-X experimental vehicle.

ACRONYMS

ACS	Attitude Control System
AEDB	Aero Dynamic Data Base
AoA	Angle of Attack
ARD	Atmospheric Re-entry Demonstrator
ATD	Aero Thermo Dynamics
ATDB	Aero Thermodynamic Data Base
CDG	Centre of Gravity
CFA	Continuum Flow Aerodynamics
CFD	Computational Fluid Dynamics
CMC	Ceramic Matrix Composite
C/SiC	Carbon / Silicon Carbide
FCS	Flight Control System
FEI	Flexible External Insulation
GNC	Guidance Navigation and Control
LTT	Laminar to Turbulent Transition
LV	Launch Vehicle
RCS	Reaction Control System
SEL	Electrical System

SPFI	Surface Protected Flexible Insulation
SRR	System Requirement Revue
SWBLI	Shock Wave Boundary Layer Interaction
SWSWI	Shock Wave Shock Wave Interaction
TAEM	Terminal Area Energy Management
THEFA	Thermographie Face Arrière
TPS	Thermal Protection System
VKI	Von Karman Institute
WRT	With Respect To
WTT	Wind Tunnel Test

SYMBOLS

α	Angle of attack
β	Sideslip
C_D	Drag coefficient
C_L	Lift coefficient
δ	Flap deflection
D	Drag of Deceleration (depending on context)
ε	Emissivity
Φ	Heat flux
γ	Flight path angle
g	Gravity acceleration
K	Ratio of experimental vehicle atmospheric density to reference vehicle one
λ	Ratio of experimental vehicle length to reference vehicle one
L	Lift
μ	Bank angle
m	Vehicle mass
M	Mach number
ρ	Atmospheric density
n	Load factor
p	pressure
Re	Reynolds number
V	Relative velocity
σ	Boltzmann constant
S	Reference surface
t	Time
T	Temperature
T_w	Wall temperature

1. INTRODUCTION

Past experience of winged and lifting body re-entry demonstration has been focused on some particular vehicles such as the USA X-15, X-38 (and others), the Russian BORs and the Japanese HYFLEX.

The Space Shuttle programme took advantage of numerous experimental lifting vehicles, such as ASSET, X-15, X-23A, X-24. An important experience in the hypersonic flight domain has been gained with X-15 in terms of thermal metallic protection, TAEM management, non-propelled landing for a vehicle with a poor L/D ratio. With ASSET and PRIME orbital and sub-orbital re-

entry flights, FCS and RCS efficiency, thermal protection system (metallic), aerothermodynamic measurements, flight worthiness, guidance accuracy have been explored. With X-24 (USAF) landing training vehicle with poor aerodynamic characteristics, transonic controllability have been investigated. A scaled model of the space shuttle has never been flown.



X-15

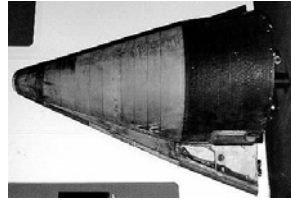

ASSET



X-23 (PRIME)



X-24A

More recently the X-38 has constituted a lifting body vehicle whose shape is very close to the X-23 experimental vehicle and it was supposed to be a scaled model of the Crew Rescue Vehicle to the international space station. ESA has been associated to this NASA program which actually stopped in 2002. The X-38 permitted to gain experience in the frame of nose and body flap technology in Europe as well as in the field of aerodynamic characterisation at high speeds, shape design, GNC, TPS architecture. A space flight has never been performed.



X-38 re-entry vehicle

Russian in-flight experimentation is mainly based on two experimental vehicles developed in the frame of the BURAN programme. Those are BOR-4 (flown between 1982-1984 up to Mach 25) and BOR-5 (flown between 1983-1988, up to Mach 18). The Russian strategy was to split the re-entry demonstration in two missions (consequently two vehicles) in order to avoid the management of the compromise between aerothermodynamic problems and aerodynamic ones, due to the scale effect of the demonstrator. As a result of that logic, BOR-4 was dedicated to orbital re-entry with a shape representative at scale 1 of the BURAN nose/windward curvature. The BOR-5 was a sub-scale of BURAN dedicated to aerodynamic efficiency, flight worthiness and GNC.

In Japan, an important fleet of experimental vehicles has been developed to support the development of the HOPE-X programme. The HYFLEX and HSFDF have been developed in this frame, but the high hypersonic domain has never been explored with a controlled glider.

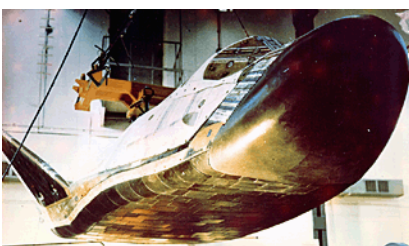

BOR 4



BOR 5



The hypersonic glider HYFLEX

The main concrete European experience in the field of re-entry is the ARD capsule, which had the same shape as the Apollo capsule with a similar descent system, but was inhabited. An important experience concerning ATD, TPS samplings, GNC, black out management, RCS attitude control has been gained. In particular, the short time available for this program and the low budget permitted to go to flight by using

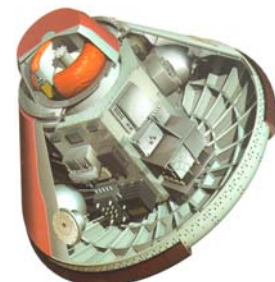

ARD re-entry capsule

“on the shelf” equipment derived from the launch vehicle Ariane 5. The system recovery and telemetry has been tested as well.

2. PRE-X REQUIREMENTS

Pre-X is an experimental lifting body whose main goal is to demonstrate that Europe has the technology to master gliding re-entry of a reusable vehicle. It is the step forward after the ARD re-entry capsule and take advantage of this past experience. This project addresses a first generation of experimental vehicle necessary in Europe for risk mitigation before opening the way for more ambitious demonstrators. Due to atmospheric re-entry specificity in terms of environment and phenomena, ground based experiments are not always representatives and in flight experimentation is mandatory. This experimental vehicle will be used for in-flight experimentation which cannot be simulated on ground.

The main objectives of experimentation are:

- Testing of reusable Thermal Protection System (TPS) subassemblies, being potential candidates for future vehicles in actual flight conditions.
- Getting Aero Thermo Dynamics (ATD) data on the most critical phenomena concerning the design and sizing of a re-entry vehicle.
- Improving the flight measurement system in consistency with pre-flight and post flight analysis to take the opportunity to fly innovative measurement.
- Designing guidance and control laws of a gliding body with body flaps.
- Performing the first design and development end to end of the hypersonic glider.
- To reduce risk for the second generation of re-entry X-vehicle.



Pre-X hypersonic glider

A procurement specification has been assessed for the Pre-X vehicle including the following constraints:

- No active oxidation during nominal trajectory¹.
- Recovery of vehicle and measures is mandatory (mission success).
- TPS expertise and dismantling without damage is mandatory.
- Recovery in sea and buoyancy during at least 48h in salty water.
- Possibility to fly on both the VEGA and DNEPR launch vehicles.
- Mission reliability 0,95 after separation of launcher.
- Safety criteria compatible with CNES safety rules.
- Ambitious design to cost objective excluding launch.
- Date of flight: year 2010.

The Pre-X vehicle has different kind of measurements:

- Technological measurements to get the necessary information in terms of environment characterisation and physical phenomena.
- Functional measurement necessary for the fulfilment of the mission and the post flight analysis.
- Innovative measurements to fly techniques never tested in flight.

¹ Active oxidation: two oxidation mechanisms are possible:

- passive oxidation, with formation of a SiO₂ solid protective layer
- active oxidation, with formation of SiO gas at the surface, which can contaminate the boundary layer.

Three main parameters drive this phenomenon: temperature, oxygen partial pressure, material microstructure.

Pre-X main purpose is to increase knowledge on re-entry phenomena and consolidate European experience in hypersonic gliding vehicles.

3. ATD TOPICS

Pre-X is an experimental vehicle whose main goal is to demonstrate some key technologies for lifting re-entry bodies. In this case the thermal protection system and the critical aero-thermo dynamic phenomena have been chosen as main experiences. The two topics are strongly connected, since the TPS architecture can influence the ATD and vice versa. Besides, the vehicle design cannot be conceived without considering the main goal of the flight, which is the demonstration. The system approach must face all these aspects together.

Form the ATD experiments point of view, the main topics identified in the Pre-X program up to the end of phase A are summarised hereafter and their priority is defined in Table 3.1 (with some more task). The location of some experiences on the vehicle (also for what concerns TPS) is shown in Fig. 3.2 and the time interval in which they can be performed is depicted in Fig. 3.3.

ATD-1: Continuum Flow Aerodynamics (CFA). The main objective of CFA experiment is to identify from flight data the aerodynamic characteristics valid over the continuum flow re-entry flight phase. Among these characteristics, the main ones are the aerodynamic coefficients (including flap efficiencies), the flap trim deflection values and flow characterisation thanks to pressure mapping.

ATD-2: High Altitude Aerodynamics (HAA). This experiment will investigate the rarefaction effects and transition from free-molecule flow (above 140 km of altitude) to transitional and then continuous flow (below 80 km).

ATD-3: Base Flow field (BF). It concerns the base flow characterisation and influence with respect to the THEFA experience.

ATD-4: Leeward Flow (LF). It consists in the characterisation of the flow filed on the leeward side, which exhibits separation patterns at high angles of attack.

ATD-5: General Heating (GH). This experiments concerns global heating of the vehicle in laminar and turbulent flow regime as well as a consequence of real gas effects (high enthalpy flow, thermochemical non equilibrium effects).

ATD-6: Wall Catalicity (WCE). The experiment concerns the wall flow field interaction due to catalytic properties of the TPS material.

ATD-7: Flap Interaction (SWBLI). It is one of the highest priority of in-flight experimentation, justified by the critical issue associated to the heat load on the deflected flap in conditions of transitional reattachment. In this case the heat flux can reach the double of the stagnation point value.

ATD-8: Jet Flowfield Interaction (JFI). This experiment is focusing on the interaction between a jet flow (coming for instance from the RCS) and the main incoming flow.

ATD-9: Laminar to Turbulent Transition (LTT). This experiment concerns the laminar to turbulent transition induced by isolated or distributed roughness on the vehicle.

ATD-10: Gap and cavity heating (GCH). This experiment concerns micro ATD in gaps and cavities and the sneak flows. This phenomenon drives the tile/shingle TPS sizing, need of gap fillers and the required tolerances on steps and gaps.

ATD-11: Plasma (P). Ionised air surrounds the vehicle during a certain part of the re-entry. This phenomenon induces black-out, whose duration and characteristics must be investigated.

hierarchy	objective
1	Flap Interaction [SWBLI] (<i>classical</i>)
2	General Heating [GH] (Real Gas markers) (<i>classical</i>)
3	Wall Catalycity [WCE]
4	Base Flowfield [BF]
5	Continuum Flow Aerodynamics [CFA] (+FADS)
6	High Altitude Aerodynamics [HAA] (rarefaction effects) (<i>classical</i>)
7	Gap and Cavity Heating [GCH] (sneak flows)
8	Leeward Flows [LF] (separation and reattachment effects)
9	Laminar-To-Turbulent Transition [LTT] (Roughness Induced)
10	Plasma (black-out) [P] (<i>classical</i>)
11	Jet-Flowfield Interaction [JFI] (including plume spreading)
12	Flap Interaction [SWBLI] (+THEFA)
13	Continuum Flow Aerodynamics [CFA] (+FADS +LIDAR)
14	General Heating [GH] (Real Gas markers) (+LIDAR)
15	Plasma (black-out) [P] (<i>multifrequency reflectometer</i>)
16	General Heating [GH] (Real Gas markers) (+LIDAR +spectro/radiomètre)
17	High Altitude Aerodynamics [HAA] (rarefaction effects) (+mass spectrograph)

Table 3.1 – ATD topics identified for the Pre-X vehicle

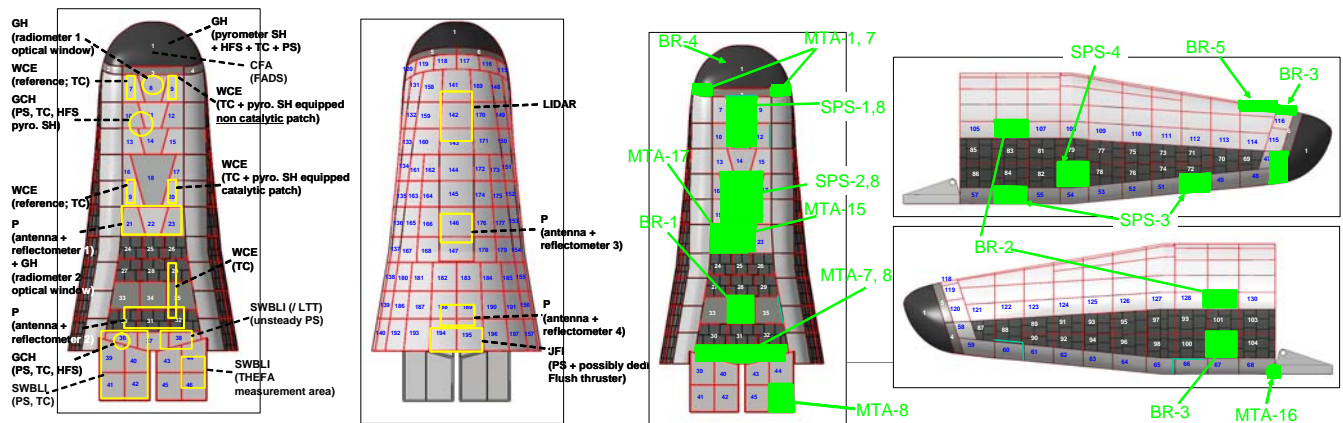

Fig. 3.2 – Location of main ATD and TPS experiences on Pre-X

Pre-X ATD/aero. IFEF - implementation of the experiments along the re-entry trajectory

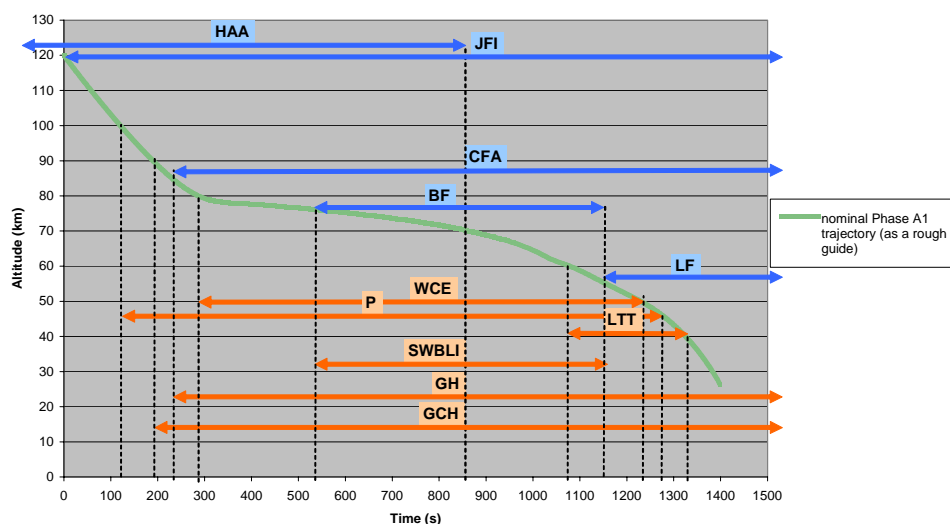
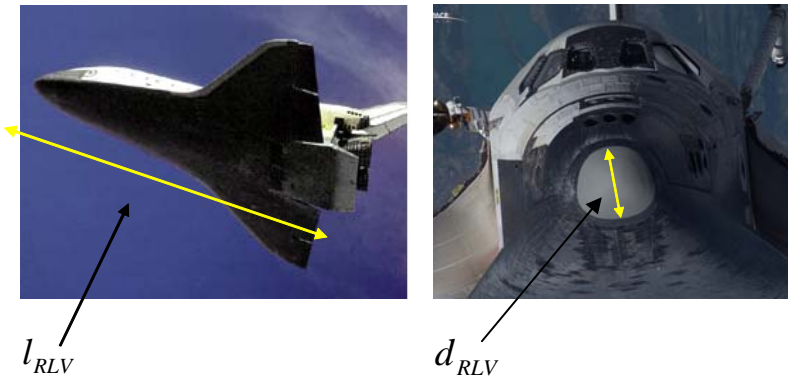

Fig. 3.3 – Time interval of occurrence for ATD experiences on Pre-X

4. SIMILARITY LAWS

As it has been stated, the objective of an experimental vehicle is to provide a flying test bed capable of capturing ATD phenomena with suitable similarity laws. Some of these phenomena are impossible to reproduce by on ground facilities because of the peculiarity of the environment for an orbital re-entry.

In order to make similarity laws, it can be useful to define some geometrical parameters to compare with a reference vehicle. For example a demonstrator and a RLV. Two typical geometric ratios can be defined, respectively for the vehicle nose and length.



$$\lambda_L = \frac{l_D}{l_{RLV}} \quad (4.1)$$

$$\lambda_D = \frac{d_D}{d_{RLV}} \quad (4.2)$$

A comparison between the Pre-X and space shuttle dimensions is given in table 4.1. As it can be seen, the nose radii have very close values, while the length ratio is about 10.

Together with the geometrical factors, a trajectory factor can be defined as the ratio of the density of a reference scale 1 vehicle and that of the scaled model:

$$K = \frac{\rho_{ref-vehicle}}{\rho_{x-vehicle}} \quad (4.3)$$

The three main similarity parameters are function of these ratios and are defined in Table 4.2.

Table 4.1 – Length ratios (mm)

	Pre-X	Shuttle	Ratio
l	4400	35000	~ 0.13
d	893(*)	670	~1.3

(*) in the case of Pre-X an equivalent radius is computed as a function of the AoA. The given value is at AoA=45°.

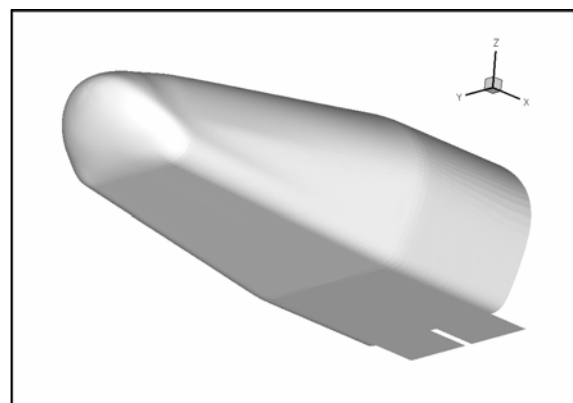

Fig. 4.1 – Pre-X current shape

Table 4.2 – Similarity parameters

Similarity Parameter	Characteristic Dimension L	Physical Phenomena	Relevant Similarity
Reynolds Number $Re = \frac{\rho V \cdot L}{\mu}$	Body Length	Viscous Effects on Flaps (SWBLI)	Major
	Nose radius	Viscous Effects on Nose / Forebody (Transition on windward side)	Major
Dissociation Parameter (Binary Mixture) $\rho \cdot L$	Body Length	Real Gas Effects (Body Flap)	Minor
	Nose radius	Real Gas Effects behind Front Shock (Stagnation Region) - Catalycity	Major
Heat Flux $\Phi_{Nose} = C \cdot \sqrt{\rho} \cdot \frac{V^3}{\sqrt{R_{Nose}}}$	Body Length		Not relevant
	Nose radius	Nose Heat Flux	Major

The main similarity parameters used the frame of ATD are the following:

- Mach number M, which gives the flow compressibility.
- Reynolds number Re, which gives the ratio between the inertial and viscous forces.
- Dissociation parameter ρL , which is tight to the gas dissociation and hence to real gas effects.
- Heat flux per unit area at nose stagnation point Φ .

The similarity parameters must be evaluated with respect to the geometric variables λ defined above, as it is shown in Table 4.2, i.e. they can be referred to different lengths.

Supposing that the scale 1 and experimental vehicle have the same velocity, similarities are respected when $\lambda/K=1$ for aerodynamics and $(\lambda \cdot K)^{0.5}=1$ for thermal flux. In particular, the following equations can be written, valid only for equal Mach number and velocity:

Aerodynamics:

$$\rho L_{x-vehicle} = \frac{\lambda}{K} \rho L_{ref-vehicle} \tag{4.4}$$

$$Re_{x-vehicle} = \frac{\lambda}{K} Re_{ref-vehicle} \tag{4.5}$$

Heat flux at nose stagnation point:

$$\Phi_{x-vehicle} = \frac{1}{\sqrt{\lambda K}} \Phi_{ref-vehicle} \tag{4.6}$$

Table 4.3 summarizes the similarity conditions for different geometrical parameters with respect to the reference vehicle, with Z the flight altitude tight to the atmospheric density.

Table 4.3 – Similarity conditions versus λ , Z

For X or RLV Similarity : Pré-X should fly			
In Case		Aerodynamics	Heat Flux
$\lambda < 1$		Lower Z	Higher Z
$\lambda > 1$		Higher Z	Lower Z

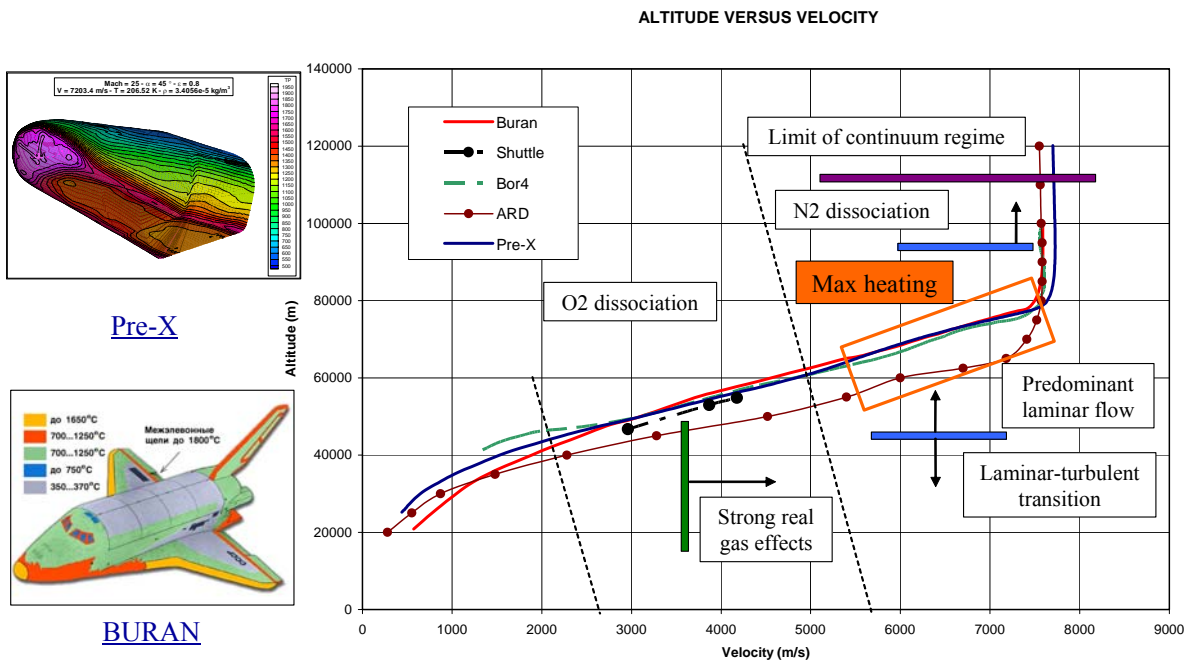

Fig. 4.2 – Pre-X re-entry path versus other re-entry vehicles

In the case of Pre-X, the velocity and altitude in the maximum heating phase are very close to those of space shuttle (Fig. 4.2). The nose has a non spherical shape and the equivalent radius must be computed through an equation, depending on the angle of attack. The nominal AoA chosen for hypersonic flight is 45 degrees. For Pre-X $\lambda_D > 1$ and $K=1$. Hence, the heat flux will be less with respect to the space shuttle one. For Pre-X $\lambda_L < 1$ and the Reynolds number will be lower by a factor 10 with respect to space shuttle. The same holds for the dissociation parameter. As it can be seen, the Pre-X design has been focused on the heat flux and ATD phenomena design more than aerodynamics.

5. VEHICLE DESIGN

The Pre-X design has been driven by the experimental objectives of section 3 and the similarity laws of section 4. The shape resulted from a long convergence process which took into account aspects such as aerodynamics, ATD, flight qualities, controllability et cetera. The sizing has been performed only in the hypersonic flight domain, between Mach 25 and 5. The other mission phases have not driven the main vehicle skills.

On the base of the high level requirement a system loop has been performed to find a compatible system. The experimentation logic has been part of the vehicle logical design and not considered as on board payloads. The system design required a high number of proposed solutions and trade-off in order to find the most suitable solution to cope with the requirements.

The vehicle had to be launched from a conventional launch vehicle and fit into the fairing. Two launch vehicles have been retained for mission: VEGA and DNEPR. One of the main trade-off consisted in choosing between orbital or sub-orbital trajectory and, the latter options has been taken.

Another important trade-off consisted in choosing between splash down or landing. Finally the splash down in Pacific ocean has been chosen as reference scenario mainly for security and cost reasons.

The reference scenario of the end of phase A was a suborbital trajectory with splash down on the East part of Pacific ocean, as depicted in Fig. 5.1. The vehicle main dimensions and masses are depicted in Fig. 5.2 and Table 5.1 to 5.3 respectively.

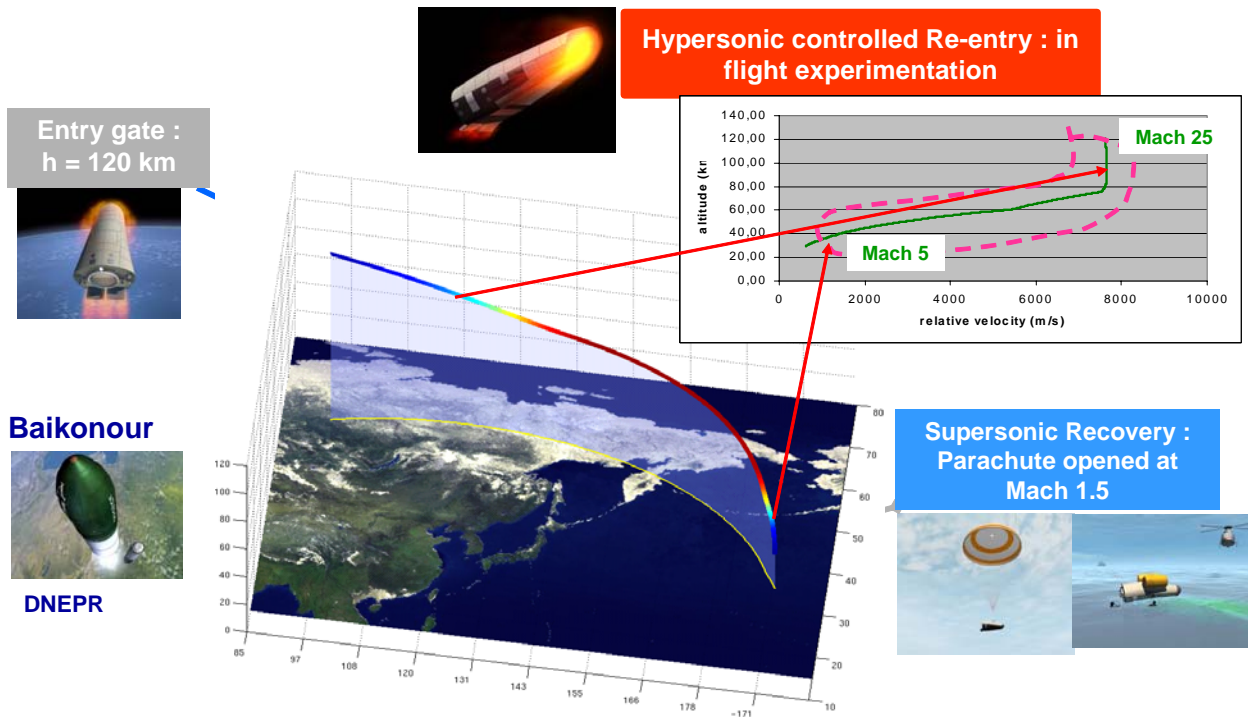

Fig. 5.1 – Reference scenario for the Pre-X re-entry experimental vehicle

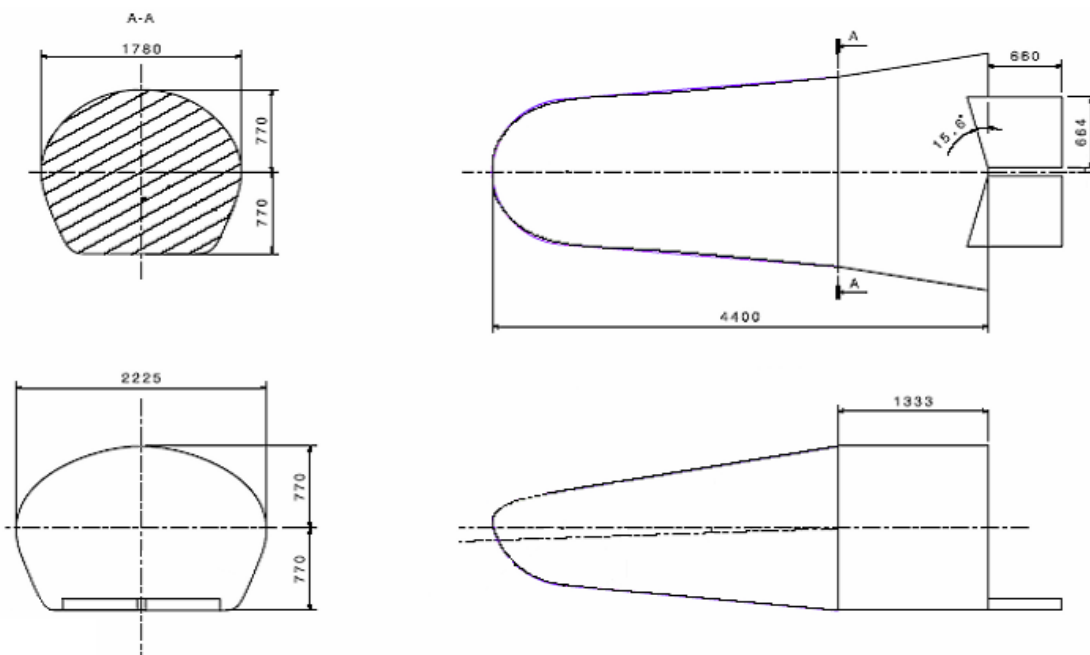

Fig. 5.2 – Main dimensions of Pre-X re-entry experimental vehicle

Table 5.1 – Pre-X mass (kg)

Nominal
1321.6

Table 5.2 – Pre-X inertia WRT centre of mass (kg m²)

Inertia	Nominal
roll axis	412
pitch axis	2115
yaw axis	2185

Table 5.3 – Centre of mass coordinates (mm)

x	y	z
1866	0	-120

As it has been said, these choices have been the consequence of a complex system loop, which permits to design the vehicle through the investigation of the different mission phases, respect of constraints, optimisation process. In an experimental re-entry gliding vehicle the main target is to perform the required in-flight experimentation securely. But this vehicle has also operational and functional requirements. Hence, two kinds of constraints must be met. The main feature of the system loop process is to take suitable margins (which are reduced during the study), perform trade-off and compromises. Margins are directly tight to cost.

A re-entry vehicle can be studied through different physical domains linked together, owing to the entire system or sub-systems. These systems can be divided into a vehicle system, launch vehicle, recovery, ground system (Fig. 5.3). The interdependence of one system with respect to another is very strong: the modification of one element can imply effects all over the others. Some of these subsystems have more functions at the same time: functional, technological, experimental. The challenge consists in designing a system capable to perform all these functions with sufficient margins, safety and limited cost.

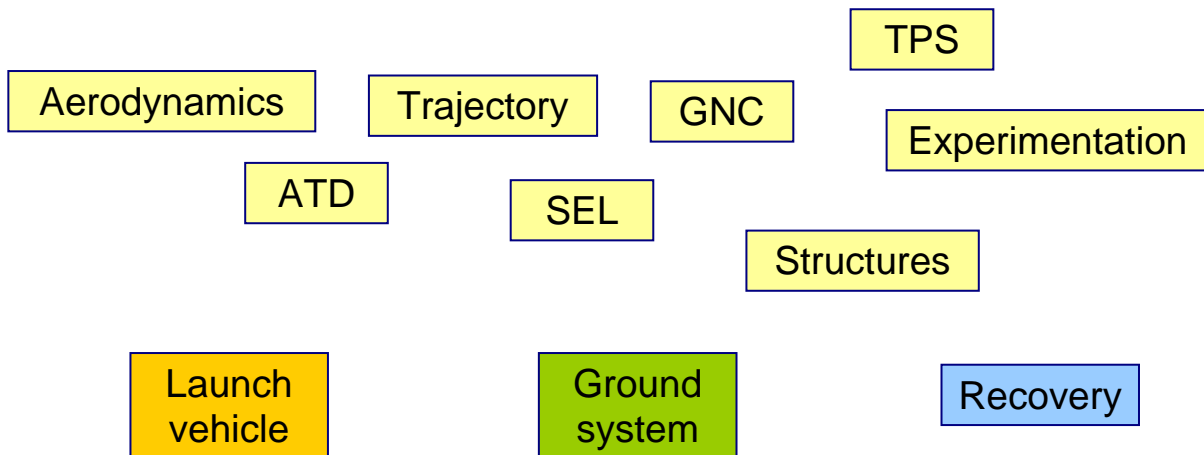

Fig. 5.3 – System and sub-system scheme

6. FLAP DESIGN

Pre-X is an experimental lifting body capable of manoeuvring with body flaps for trim and three axes control during the atmospheric re-entry. The attitude control is also performed by thrusters (Reaction Control System) derived from the Ariane 5 ACS.

The choice to have a lifting body with body flaps has been driven by the existence of a European maturity at Man Technology Aerospace (MTA) gained during the X-38 program in cooperation NASA-ESA. This component has been qualified on ground. The Pre-X flaps are very close to those conceived for X-38 and smaller in size. This sub system is a main functional device and at the same time object of experiences. A summary of the main tasks is given hereafter:

Main experiences:

- Shock Wave Boundary Layer Interaction
- C/SiC material testing
- Laminar Turbulent Transition

Main functions:

- Provide vehicle attitude control
- Guarantee vehicle trim

Main constraints:

- Avoid active oxidation (Fig. 6.1)
- Keep a given range of heat flux

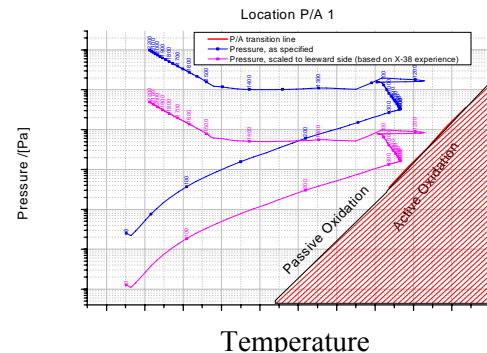

Fig. 6.1 - Active oxidation constraint

The driving parameters of flaps design are mainly trajectory, vehicle size, angle of attack, sideslip, flap shape and deflections. The design chosen today is depicted in Fig. 6.2: the flaps are deflected independently for pitch and roll control, trim and provide a slight lateral control. Hence they can work as “elevators” or “ailerons”. The lateral control is provided by non convergent hinge lines.

They are constituted by a single mould of C/SiC and driven by electro mechanical actuators. These are designed such that the kinematics belongs to a same plane. The minimum and maximum deflections are -10° and 35° .

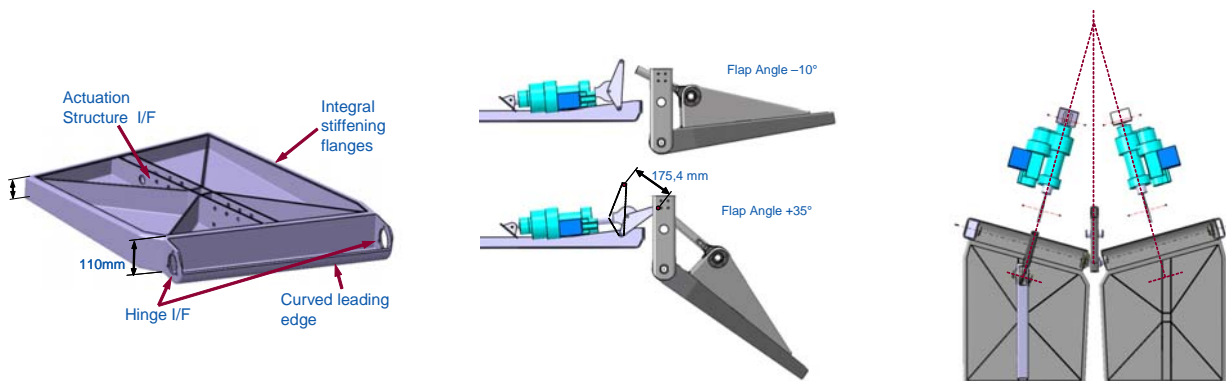

Fig. 6.2 – Pre-X Body flaps configuration (MTA)

The body flaps have an on board experience THEFA (Fig. 6.3), which should permit to reconstruct the windward heat flux and temperature profile from the back face temperature distribution. This possibility is limited mainly by the flap thickness, vibration, plane surface and absence of pollution. This device permits to reconstitute also the thermal history of flaps.

Goal : measurement of heat fluxes in aggressive environment

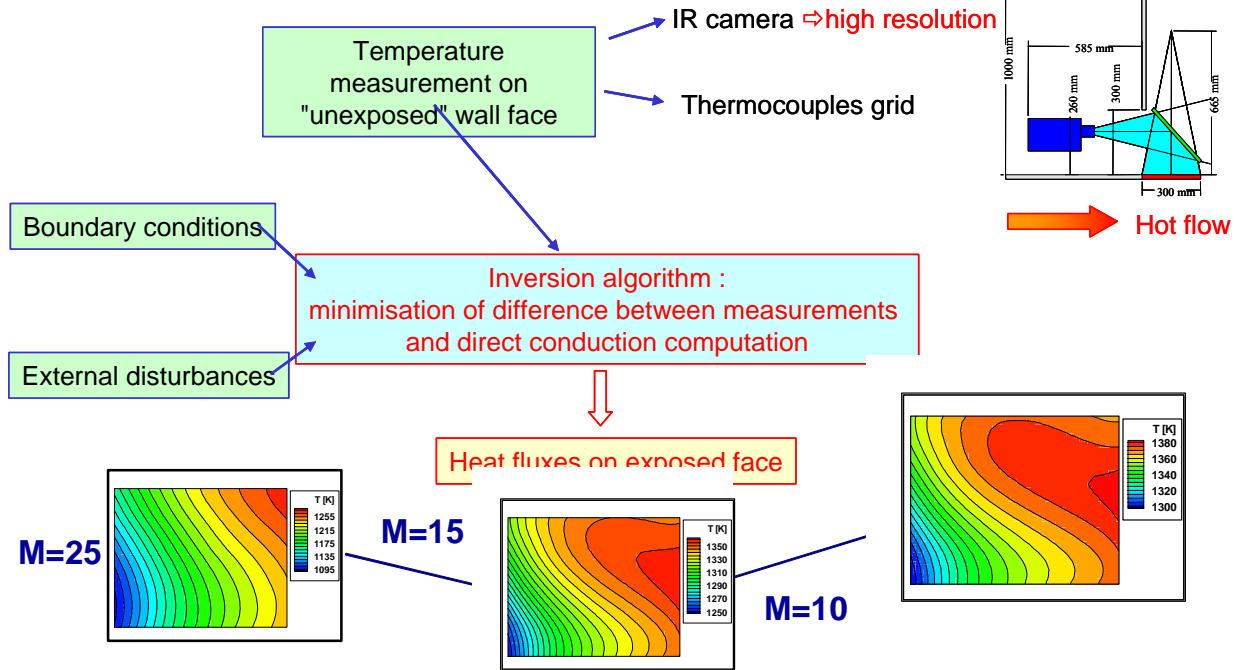

Fig. 6.3 – The THEFA experiment

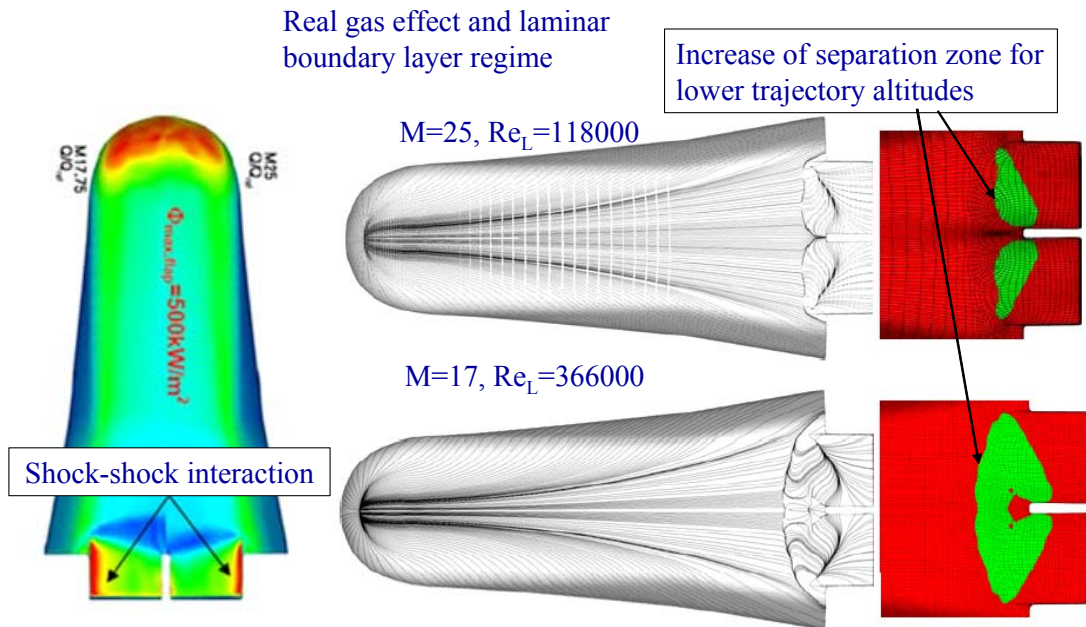

Fig. 6.4 – Separation zone and shock-shock interaction (ONERA)

As it has been said, at the body flaps the laminar to turbulent transition (LTT), SWBLI, SWSWI can be observed for certain angles of attack, flow conditions and flap deflections. A specific study has been performed by means of CFD, and wind tunnel tests. Some main results are presented in Fig. 6.4 for Mach 17 and 25 in laminar fluid flow. The separation region increases for lower Mach number and higher Reynolds number. A specific study has been performed to catch the laminar to turbulent transition at different Mach numbers by ONERA through numerical methods which

permit to predict instabilities of the boundary layer and their characteristic frequency. This frequency is an important information for establishing the sensors bandwidth for measurement of the phenomenon. As it is well known, this transitional regime is dangerous for flaps heating.

In summary, the flap design is resulting from a compromise between experiences to be implemented and functional needs: for the former objective higher deflections are necessary, for the latter low deflections are preferred (vehicle safety). A main trade-off is undergoing about this matter.

7. SYSTEM LOOP

The overall system design must consider all the subsystems recalled in Section 5, considering the re-entry corridor defined mainly by the entry parameters, GNC, material properties and experiences to be implemented.

For most of the re-entry the main goal is to decrease the vehicle energy and recover the spacecraft as safe as possible. With respect to energy management, a conventional and useful representation of the flight range in hypersonic regime during re-entry is to compute the relative velocity versus deceleration D :

$$D = \frac{1}{2} \rho V_{rel}^2 \frac{SC_D}{m} \quad (7.1)$$

Four main constraints are identified:

The equilibrium gliding limit

$$\rho_{glide} = \frac{2.m}{S.C_L} \cdot \frac{1}{V^2} \left[\frac{d\gamma}{dt} V + \cos \gamma \left(g - \frac{V^2}{R} \right) \right] \quad (7.2)$$

The thermal limit.

$$\rho_{stag_max} = \left[\varepsilon \cdot \sigma \cdot T_{stag_max}^4 \cdot \left(\frac{\sqrt{R_n}}{Cq} \right) \cdot \frac{1}{V^3} \right]^2 \quad (7.3)$$

The dynamic pressure constraint.

$$D_{P_{dyn}} = P_{dyn_max} \cdot \frac{SC_D}{m} \quad (7.4)$$

The mechanical loads.

$$D_{tot_load} = \frac{n_{tot_max} \cdot g}{\sqrt{1 + \left(\frac{C_L}{C_D} \right)^2}} \quad (7.5)$$

$$D_{trans_load} = \frac{n_{trans_max} \cdot g}{\sqrt{\sin \alpha + \left(\frac{C_L}{C_D} \right) \cdot \cos \alpha}} \quad (7.6)$$

These constraints expressed in the deceleration – velocity plane give the ideal re-entry corridor (Fig. 7.1). The actual thermal limit is given by that of thermal protections installed on the vehicle. The definition of the TPS architecture is given by the system loop process by eliminating those thermal protections for which the corridor is too small.

The trajectory is the starting point of the loop: it permits to assess the thermo-mechanical loads, recovery point, perform visibility analysis, risk analysis. The vehicle aerodynamic and aerothermic data base are needed. GNC permits to control the vehicle flight path and attitude during re-entry. Typically an angle of attack is imposed and the vehicle must follow a prescribed Deceleration - Velocity path. Down range is controlled through bank angle (angle about velocity vector) variation and cross range through roll reversal (opposite sign variation of bank angle).

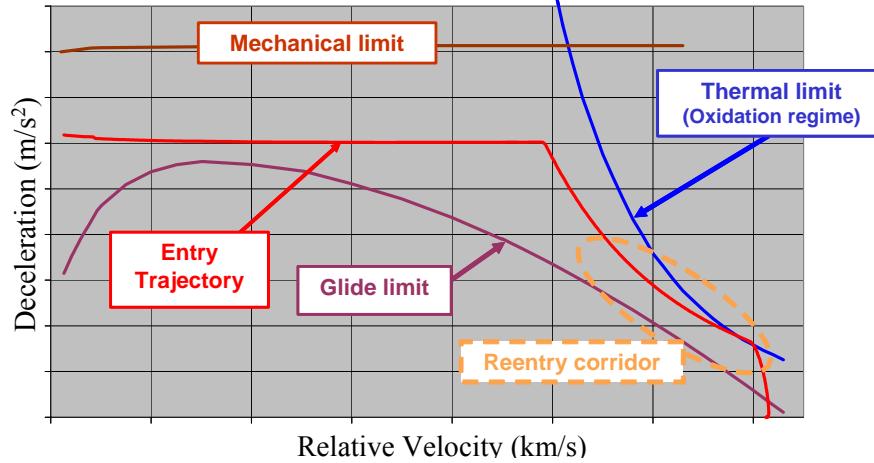

Fig. 7.1 – Re-entry corridor

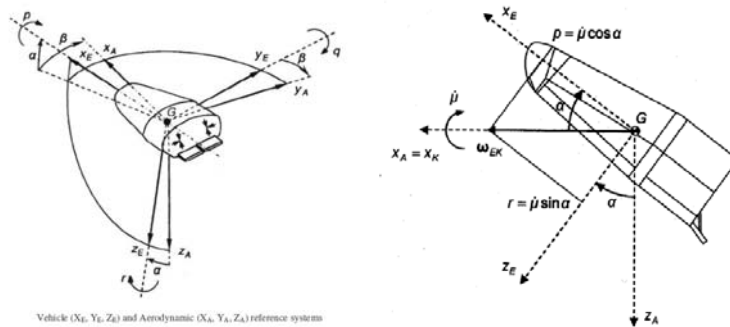

Fig. 7.2 – Pre-X vehicle and aerodynamic axes definition (α =angle of attack, β =sideslip, μ =bank angle)

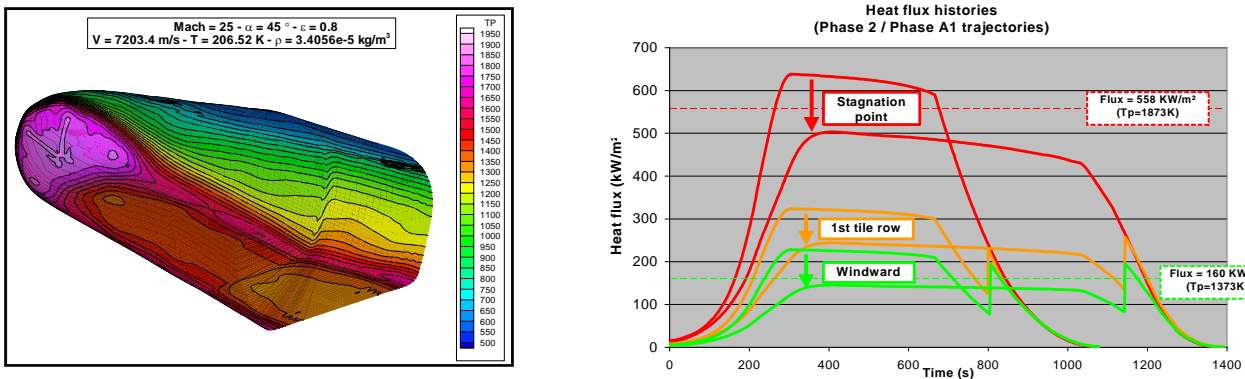

Fig. 7.3 – Pre-X temperature pattern

TPS technology		Limit T (C°)
Nose		1600
Windward shingle		<1600 >1100
SPFI		1200
Bonded tiles		1250
Metallic	Ti Al	850
	ODS	1000
FEI	FEI 450	450
	FEI 650	650
	FEI 1000	1000
	FEI 1100	1100
Flaps		1100
Large shingle		1400

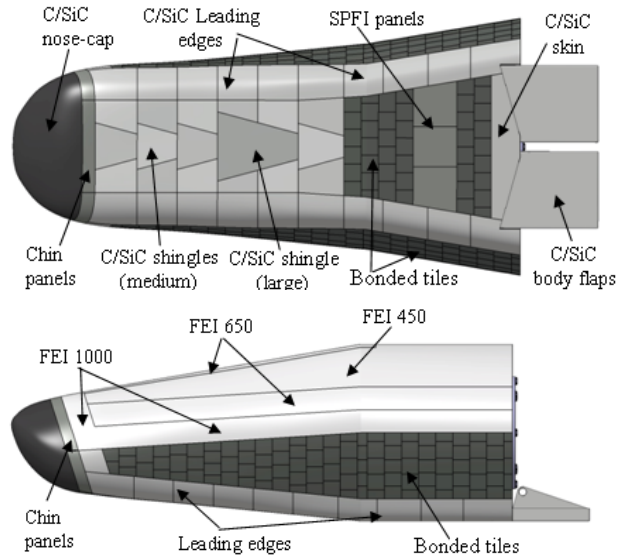

Fig. 7.4 – Pre-X TPS architecture

With the new trajectory, the updated thermal flux and temperature distribution on the vehicle can be computed and some choices performed. Typically, from phase 2 to phase A, the heat flux evolution along the trajectory has been changed in order to get lower peaks for a longer time (Fig. 7.3). The laminar to turbulent transition still occurs when the heat flux is decreasing (peaks at about 1200 seconds). The sizing temperature pattern on the vehicle has been computed by means of CFD (Fig. 7.3) and permitted to define the TPS architecture and location of experiences, considering a maximum admissible temperature of the structure including margins. The TPS architecture has been derived from the temperature distribution, following the material maximum admissible temperature values (Fig. 7.4). The trend of temperature in different control points for C/SiC is given in Fig. 7.5.

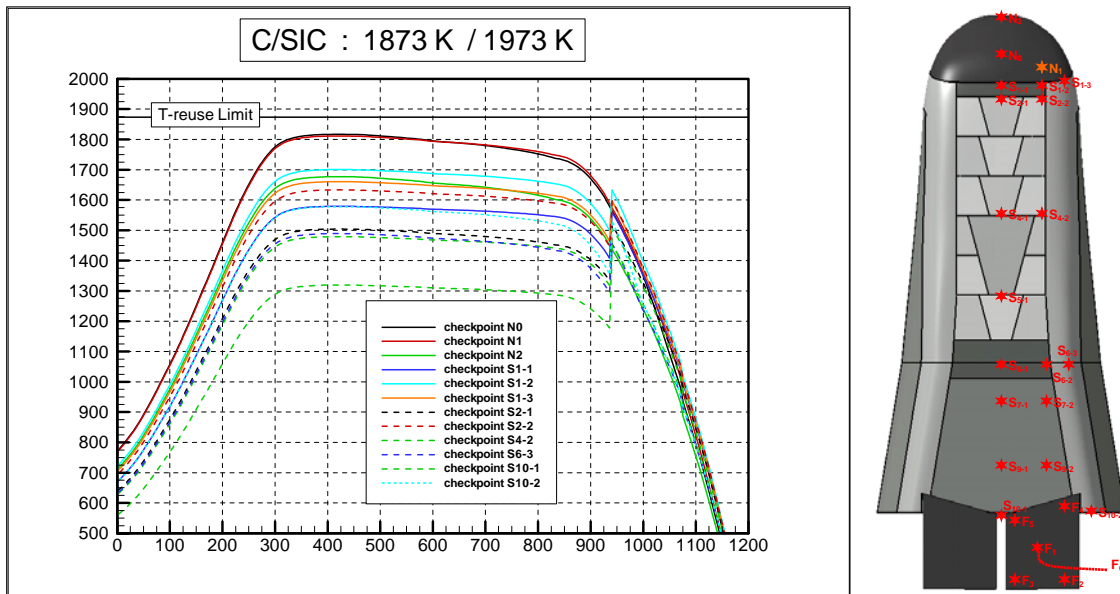

Fig. 7.5 – Temperature behaviour for C/SiC control points

Once the TPS architecture has been defined, a more representative diagram can be drawn for Pre-X including all the materials thermal limits. Fig. 7.6 refers to a re-entry corridor with angle of attack of 45 degrees and flap deflection of about 10 degrees. The entry conditions at 120 km are the relative velocity 7700 m/s and the flight path angle -1.25 degrees. The equilibrium glide curve is the black one in which some Mach numbers are indicated. The other curves indicate the limits of TPS,

the LTT, SWSWI, the passive of active oxidation boundary et cetera. The accessible corridor is between the equilibrium glide and the other curves. As it can be seen, the use of metallic panel is not possible, since it is obtruding the corridor between Mach 20 et 15. However, the critical passage is near Mach 15.

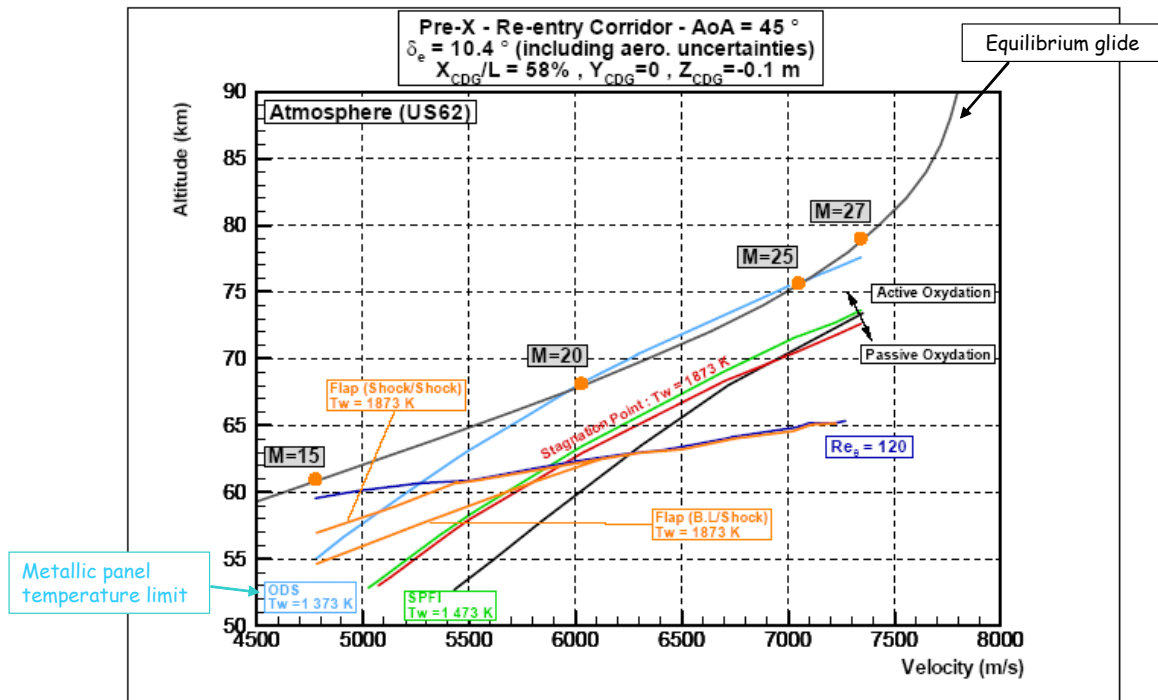

Fig. 7.6 – Re-entry corridor in terms of velocity versus altitude including material limits

8. CONCLUSIONS

Pre-X project addresses a first generation of experimental manoeuvrable lifting body necessary in Europe for risk mitigation before opening the way for more ambitious demonstrators. The main experiments concern TPS, ATD and secondarily GNC and avionics. The vehicle design must comply with the in-flight experimentation plan and the system choices are strictly tight to it. In particular a trade-off is needed between the vehicle operational and functional requirements and the in-flight experiments. A suitable compromise must be assessed. The body flaps design is a typical example of sub system in which these function and experimental aspects are concentrated at the same time. The risk of vehicle loss must be mitigated as well as the experiences investigated, since they are the objective of Pre-X flight.

This paper has shown some examples of system and sub system design, the logic of system loop and kind of problems that must be faced during this process. Of course this is a non exhaustive panorama, which represents the situation of the project at the end of phase A.

AKNOWLEDGMENTS

The author wish to acknowledge all the industrial team who participated in Pre-X and made this work possible with his contribution and Sylvain Guedron for his expertise, advice and continuous support to the project.

REFERENCES

1. AVP-DP-220 0000-01-CNES-01, “ANGEL, Advanced New Generation European Launcher, PROGRAMME PROPOSAL”, 12 July 2001.
2. AVP-CF-2310000-01-CNES-03, “Pre-X project procurement specification ”, May 9th 2005.
3. AVP-NT-2319000-01-EADS-ST-01, “Pre-X – Phase A2, Preliminary in-flight experimentation plan”, 15/09/2005.
4. J. Moulin, “System design constraints trade-off and optimisation”, VKI lecture.
5. E. Cosson et Al., “Aerothermodynamics in the heart of the re-entry vehicle shape design and mission analysis matters”,
6. E. Cosson et Al., “Pre-X aerothermodynamics implications at system level”.
7. F. Thivet et Al., “Detailed aerothermodynamical analysis of Pre-X”.
8. K. Handrick et Al., "Active body flap for Pre-X experimental vehicle: preliminary design, analyses and manufacturing choices”, Arcachon, 21-23 March 2005.
9. Y. Gerard, J. Moulin, “The hypersonic Pre-X vehicle: current status”, IAC-04-V.6.
10. YX/FA n°137079, “Pre-X Phase 2: Représentativité aérodynamique Pre-X/RLV », 04/09/2002.
11. S. Guedron et Al., « Glided atmospheric re-entry: a bridging phase towards a European program”, ISTS-2004-g-13.